

Winbond W682388

Dual Programmable Extended CODEC/SLIC

The W682388 implements a dual channel FXS telephone line interface optimized for short loop applications. It integrates dual SLIC (Subscriber Line Interface Circuit) functionality with a dual channel programmable CODEC and a dual DC-DC controller. The SLIC supports internal ringing up to 90V_{PK} (5REN at 4kft), ideal for customer premise equipment (CPE). The CODEC can be configured for μ -law/ A-law or 16-bit linear PCM encoding and supports a comprehensive set of signaling capabilities required to supervise and control both telephone lines. These include tone generation (including ring tones), DTMF generation and detection as well as FSK and metering pulse generation. An on-chip dual pulse width modulation (PWM) driver allows the control of DC-DC conversion for each line. Programmable impedance and transhybrid balancing allow for worldwide deployment.

APPLICATIONS

- Analog Telephone Adapter
- Voice enabled DSL Modems
- Voice enabled Cable Modems
- Residential VoIP Gateways / Routers
- Integrated Access Devices
- Fiber to the Premise/Home (FTTP/H)
- Optical Network Terminals (ONT)
- Set Top Boxes
- Wireless Local Loop
- PBX
- ISDN NT1/TA

FEATURES

- Performs complete BORSCHT functions for two channels on a single device
- Internal balanced ringing up to 90V_{PK} (5REN up to 4kft)
- Integrated Power Management
 - Integrated DC-DC controller regulates battery voltage to minimize power dissipation in all operating modes
- Programmable linefeed characteristics
 - Ringing frequency, amplitude, cadence
 - Trapezoidal and Sinusoidal waveforms
 - Two-wire AC impedance, transhybrid balance
 - Constant Current feed (20 to 41mA)
 - Ring trip and loop closure thresholds
- Programmable signal generation
 - DTMF generation and detection
 - Metering pulse generation (12/16kHz)
 - Enhanced Caller ID (FSK) generation (Type I and Type II)
 - Tone generation (up to four simultaneous)
 - G.711 μ -Law/A-Law / 16-bit linear PCM audio
- Loop test and diagnostics support
 - Integrated loopback modes
 - Realtime linefeed monitoring
 - On-chip temperature sensor
- PCM and SPI bus digital interfaces
 - PCM Master and Slave modes supported
- On-chip PLL for flexible clocking options including 1MHz / 2MHz
- 3.3V operation
- Small Footprint Packages: LQFP-64, QFN-64

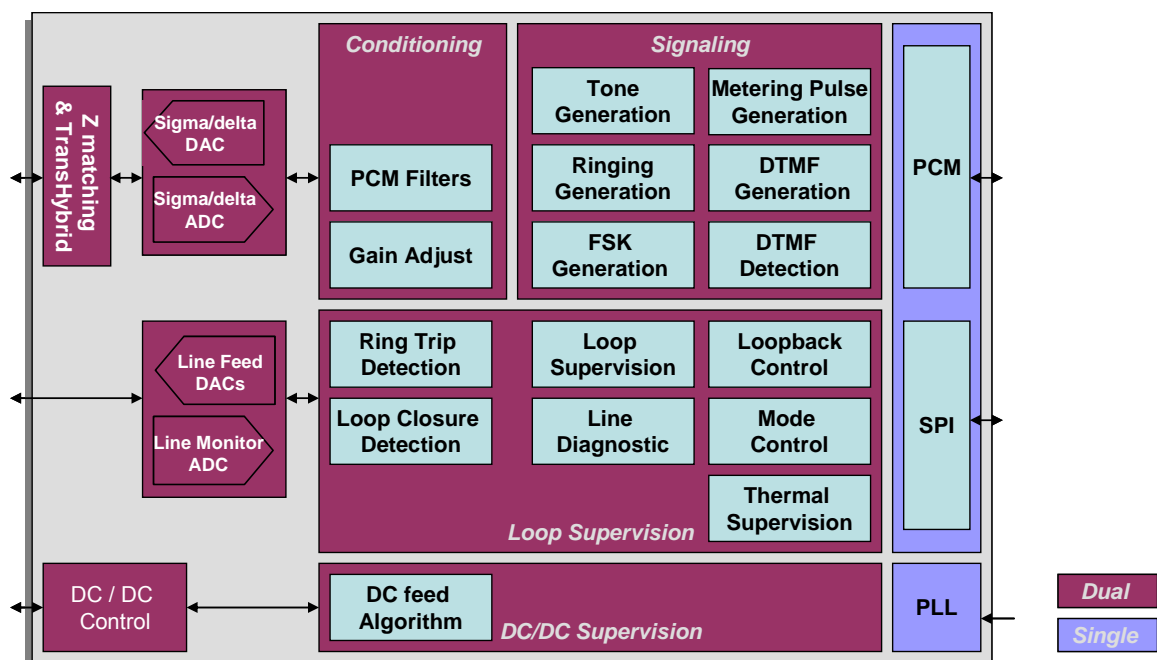

Application Example: Analog Telephone Adapter (ATA) supporting 2 voice ports

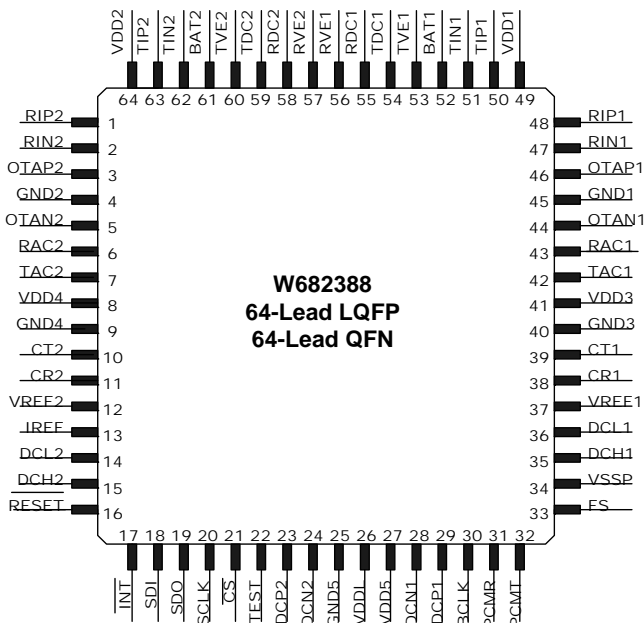
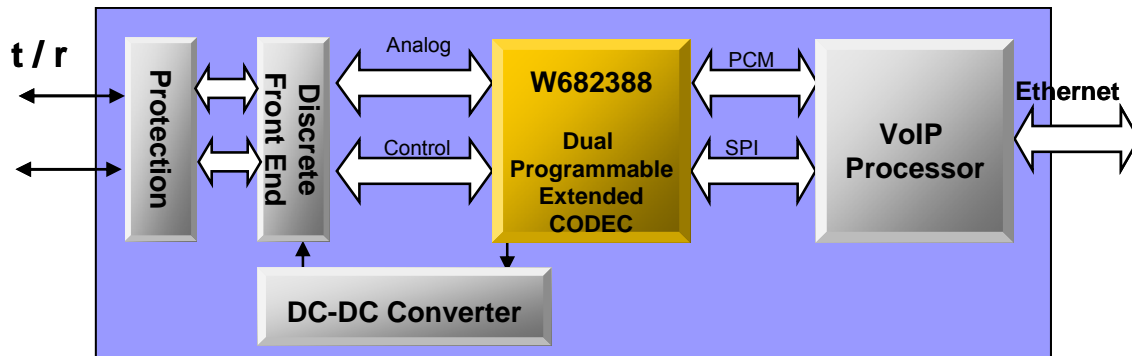

BENEFITS

- High integration reduces overall system BOM and footprint
- Low power consumption for battery-backup and other power sensitive applications
- High programmability reduces real-time software overhead
- Extensive line sensing enables diagnostics support

W682388 ORDERING INFORMATION

Part Number	Package	Notes
W682388DG	LQFP-64	RoHS
W682388YG	QFN-64	RoHS

Note: For more details on the W682388, please refer to Winbond America's web site at: <http://www.winbond-usa.com>



Winbond is a registered trademark of Winbond Electronics Corporation. All other trademarks and logos are the properties of their respective owners.

Winbond Electronics Corporation America
2727 North First Street
San Jose, CA 95134, U.S.A.
TEL: 1-408-474-1612 (Americas)
TEL: 1-408-474-1671 (Europe)
FAX: 1-408-544-1787

Winbond Electronics (Shanghai) Ltd./Shenzhen
15F, New World Commercial Center
6009 Yi Tian Road
Fu Tian District, Shenzhen, P.R. China
TEL: 86-755-83515350
FAX: 86-755-83515348

Winbond Electronics Japan
No. 2 Ueno-Bldg., 7-18, 3-chome
Shinyokohama Kouhoku-ku
Yokohama-shi, 222-0033 Japan
TEL: 81-45-4781881
FAX: 81-45-4781800

Winbond Electronics (H.K.) Ltd.
Unit 9-15, 22F, Millennium City 2,
378 Kwong Tong Rd.
Kowloon, Hong Kong
TEL: 852-27513100
FAX: 852-27552064

Winbond Electronics (Taipei)
9F, No. 480, Rueiguang Rd.
Neihu Chiu
Taipei, 114, Taiwan
TEL: 886-2-81777168
FAX: 886-2-87153579

Winbond Electronics Ltd.
27F, 2299 Yan An Road (West)
Shanghai, P.R. China 200336
TEL: 86-21-62365099
FAX: 86-21-62365998